

### Typical Features

- ◆ Fixed input voltage, Isolated & unregulated output, Output power 1W
- ◆ High Efficiency up to 86%
- ◆ Small compact DIP packing
- ◆ Isolation Voltage 1500VDC
- ◆ Operating Temperature: -40°C ~ +105°C
- ◆ Plastic Case, meet UL94 V-0 standard

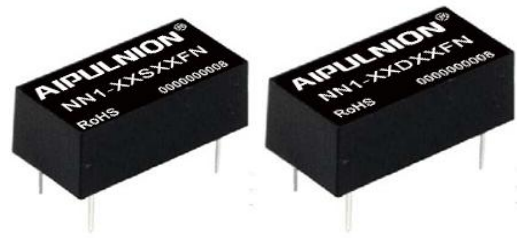

**Test Condition:** Unless otherwise specified, data in the datasheet should be tested under the conditions of input nominal voltage, pure resistance rated load and Ta=25°C

### Application Field

*It could be widely used for instrument, communication, pure digital circuit, general low frequency analog circuit, relay drive circuit, data exchange circuit, etc.*

### Typical Product List

Part No.	Input Voltage Range (VDC)		Output Voltage/ Current (Vo/Io)		Input Current(mA) Nominal Voltage		Max. Capacitive Load uF	Ripple & Noise (Max.) mVp-p	Efficiency (%)full load, input nominal voltage	
	Nominal	Range	Voltage (VDC)	Current(mA) MAX./Min.	Full load Typ.	No Load Typ.			Min.	Typ.
NN1-05S3V3FN	5	4.5 - 5.5	3.3	303/30	250	8	2400	100	78	82
NN1-05S05FN			5	200/20	225	8	2400	100	81	85
NN1-05S12FN			12	83/9	220	12	560	100	81	85
NN1-05S15FN			15	67/7	220	18	560	100	81	85
NN1-12S05FN	12	10.8	5	200/20	96	10	2400	100	81	85
NN1-12S12FN		-	12	83/9	90	10	560	100	82	86
NN1-12S15FN		13.2	15	67/7	90	10	560	100	82	86
NN1-24S05FN	24	21.6	5	200/20	47	8	2400	100	80	84
NN1-24S12FN		-	12	83/9	48	8	560	100	82	86
NN1-24S15FN		26.4	15	67/7	48	8	560	100	81	85
NN1-05D05FN	5	4.5	±5	±100/±10	236	8	2400	100	78	82
NN1-05D12FN		-	±12	±42/±5	232	12	2400	100	79	83
NN1-05D15FN		5.5	±15	±34/±4	232	20	560	100	79	83
NN1-12D05FN	12	10.8	±5	±100/±10	96	10	2400	100	78	82
NN1-12D12FN		-	±12	±42/±5	90	10	2400	100	79	83
NN1-12D15FN		13.2	±15	±34/±4	90	10	560	100	79	83

NN1-24D05FN	24	21.6	±5	±100/±10	47	8	1200	100	78	82
NN1-24D12FN		-	±12	±42/±5	48	8	220	100	79	83
NN1-24D15FN		26.4	±15	±34/±4	48	8	220	100	79	83

Note: 1.In order to ensure the converter can work reliably with high efficiency, the minimum load should not less than 10% rated load when it is used. If the needed power is indeed small, please parallel a resistor at the output side, the resistance recommended equal to 10% nominal power.

2.the capacitive load of positive and negative output are same.

**Input Specifications**

Item	Working Conditions	Min.	Typ.	Max.	Unit
Input Overshoot Voltage (1Second.max.)	5Vdc Input	-0.7	--	9	VDC
	12Vdc Input	-0.7	--	18	
	24Vdc Input	-0.7	--	30	
Input Filter	Capacitor Filter				

**Output Specifications**

Item	Working Conditions	Min.	Typ.	Max.	Unit
Output Power		0.1	--	1	W
Output Voltage Accuracy	Nominal input, Full load	--	±2	±5	%
Load Regulation	10% ~ 100% nominal load	--	--	15	
Line Voltage Regulation	Input Voltage Change±1%	--	--	±1.2	
Ripple & Noise①	Nominal input, full load, 20MHZ bandwidth	--	75	100	mVp-p
Temperature Drift Coefficient	100% Full Load	--	--	±0.03	%/°C
Output Short Circuit Protection	Continuous short-circuit protection, self-recovery				

NOTE:①Ripple & Noise tested by twisted-pair method;

**General Specifications**

Switching Frequency	Nominal Input, Full load	260KHz (Typ.)
Operating Temperature	Refer to Temperature Derating Curve	-40°C ~ +85°C
Storage Temperature		-55°C ~ +125°C
Shell temperature rise during work	Within Temperature Derating Curve	25°C(Typ.)
Relative Humidity	No condensing	5%~95%
Case Material		Black flame-retardant heat-resistant Plastic(UL94 V-0)
Pin withstand solder temperature	Distance to case 1.5mm, 10Seconds	300°C MAX
Isolation Voltage	Test 1 minute, leakage current< 0.5mA	1500Vdc
Isolation Capacitor	Input/Output,100KHz/0.1V	20 pF (Typ.)



MTBF	MIL-HDBK-217F@25°C	35X10 <sup>5</sup> Hrs
Product Weight		2.5g (Typ.)
Packing	Tube(525*18*10mm)	25PCS
	Box(542*110*155mm)	2000PCS(Total 80tubes)

**Packing Dimension**

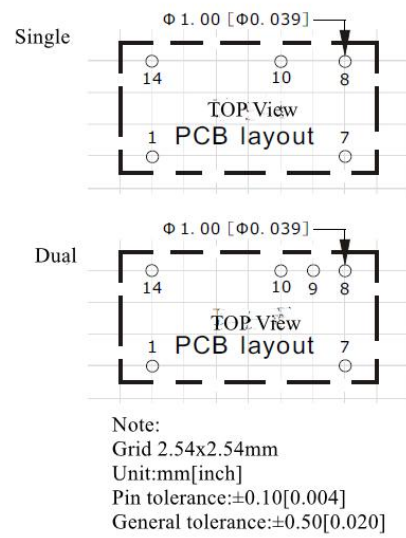
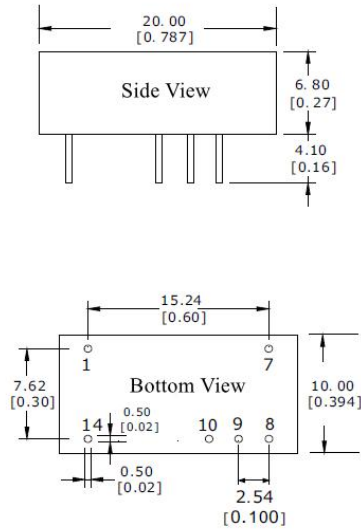

Packing Code	L x W x H	
F	20.00 × 10.00 × 6.80mm	0.787 × 0.394 × 0.270inch

**Pin Function**

Pin Function	1	7	8	9	10	14
Single(S)	GND	NC	-Vo	+Vo	NP	+Vin
Dual(D)	GND	NC	COM	+Vo	-Vo	+Vin

Note: if the definition of pin is not in accordance with the model selection manual, please refer to the label on actual item.

**Temperature Curve**

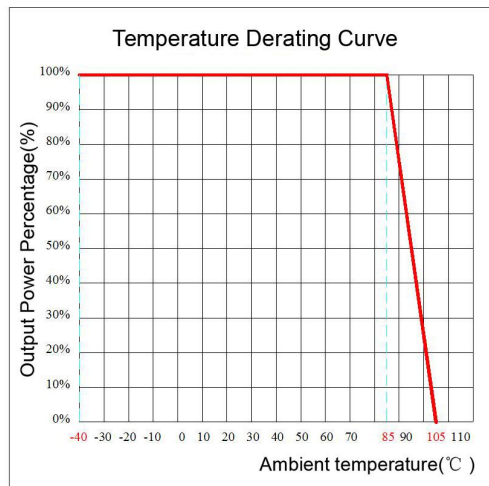

**Design and Application Circuit Recommended**

**1. Output load requirements**

- a. In order to ensure the converter can work reliably with high efficiency, the minimum load should not less than 10% rated load when it is used. If the needed power is indeed small, please parallel a resistor at the output side, the resistance equal to 10% nominal load.
- b. The maximum capacitive load is tested under nominal input full load, and cannot exceed the maximum capacitive load of output terminal under operation, otherwise it will cause it difficult to start up and damage the product.

**2. Recommended circuit**

In order to ensure the input/output ripple and noise decreased, capacitor filter net could be connected to input and output terminal, application circuit as below photo 1; choosing suitable filter capacitor is very important, start-up problems may be caused by too large capacitance. To ensure the modules running safely and reliably, the recommended capacitive load values as shown in Table 1.

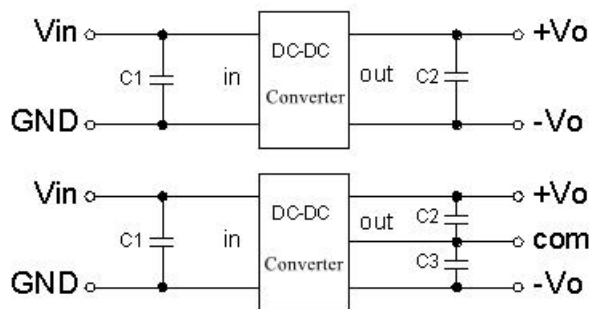

Recommended capacitive load value (Table 1)

Vin (Vdc)	C1 (µF)	Vout (Vdc)	C2 (µF)	Vout (Vdc)	C2,C3 (µF)
3.3/5	4.7	3.3/5	10	±3.3/±5	4.7
12	2.2	9	4.7	±9	2.2
15	1	12	2.2	±12	1
24	1	15	1	±15	0.47
..	..	24	0.47	±24	0.22

**3. Ripple & Noise Test: (Twisted Pair Method 20MHZ bandwidth)**

- a. 12# twisted pair to connect, Oscilloscope bandwidth set as 20MHz, 100M bandwidth probe, terminated with 0.1uF polypropylene capacitor and 10uF high frequency low resistance electrolytic capacitor in parallel, oscilloscope set as Sample pattern.
- b. Input terminal connect to power supply, output terminal connect to electronic load through jig plate, Use 30cm±2 cm sampling line, Power line selected from corresponding diameter wire with insulation according to the flow of output current.

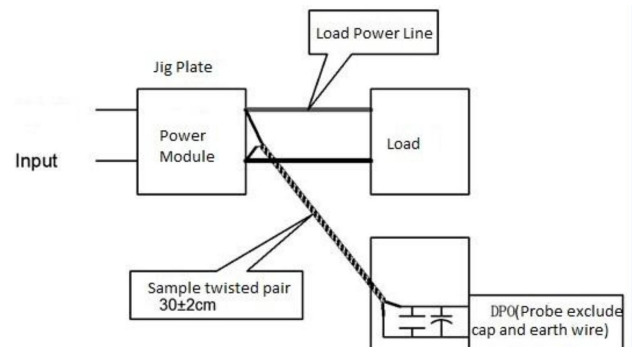

**4. Output regulated voltage and over voltage protection circuit**

The simplest device to protect output regulated voltage, over voltage and over current is to cascade a linear regulator with overheat protection at input or output terminal, and connect a capacitor filter net (see below picture), filter capacitive value recommended see table 1, Linear regulator is chosen according to the actual voltage, current needed in working, or choose our NW series products.

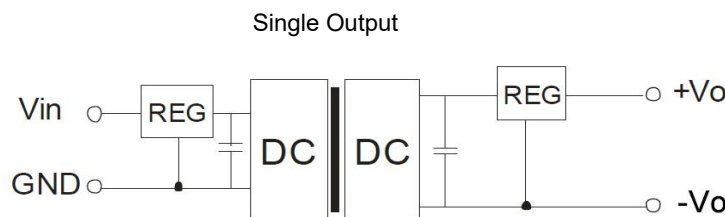

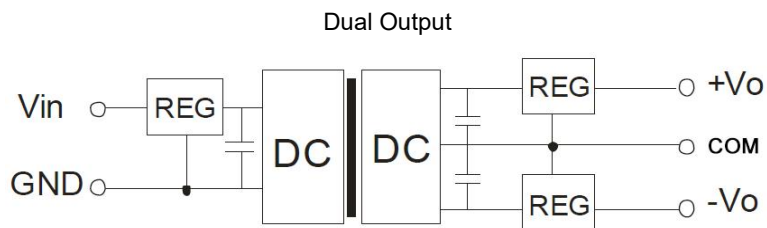
**Note:**

1. This product cannot be used in parallel, and do not support hot-plugging;
2. If the product works below the minimum required load, it cannot guarantee that the product performance meets all performance indicators in this manual;
3. All index testing methods in this datasheet are based on our Company's corporate standards
4. The product specification may be changed at any time without prior notice.