

Typical Feature

- ◆ Fixed Input Voltage, isolated & regulated Output, power 0.75W
- ◆ High efficiency up to 75%
- ◆ Small SMD package, international standard pin out
- ◆ Isolation Voltage 1500VDC
- ◆ Operating Temperature: -40°C to +85°C
- ◆ Plastic case, meet to UL94 V-0 standard



Application Filed

Widely used in instrumentation, communication, pure digital circuits, general low-frequency analog circuits, relay drive circuits, data exchange circuits, etc.

Typical Product List

Part No	Input voltage range (VDC)		Input Voltage/Current(Vo/Io)		Input Current(mA) Nominal voltage		Max capacitive load uF	Ripple & Noise Max mVp-p	Efficiency (%)@full load, nominal input voltage	
	Nominal	Range	Voltage (VDC)	Current (mA)MAX./Min.	Full load typ.	No load typ.			Min.	Typ.
NWV75-05S3V3ANT	5	4.75	3.3	200/20	200	6	2400	80	67	70
NWV75-05S05ANT		-	5	150/15	205	6	2400	80	70	73
NWV75-05S12ANT		5.25	12	62/7	186	8	560	80	72	75
NWV75-12S3V3ANT	12	11.4	3.3	200/20	86	8	2400	80	67	70
NWV75-12S05ANT		-	5	150/15	83	8	2400	80	70	73
NWV75-12S12ANT		12.6	12	62/7	83	8	560	80	72	75
NWV75-24S3V3ANT	24	22.8	3.3	200/20	45	8	2400	80	67	70
NWV75-24S05ANT		-	5	150/15	41	8	2400	80	70	73
NWV75-24S12ANT		25.2	12	62/7	41	8	560	80	72	75

In order to ensure that the module can work efficiently and reliably, when in use, the minimum output load cannot be less than 10% of the rated load. If the power you need is really small, please connect a resistor in parallel at the output end, the recommended resistance is equivalent to 10% of the rated power.

Input Specifications

Item	Operating Condition	Min.	Typ.	Max.	Unit
Input Overshoot Voltage	5Vdc Input	-0.7		9	VDC
	12Vdc Input	-0.7		18	

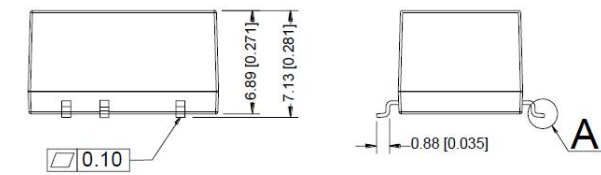
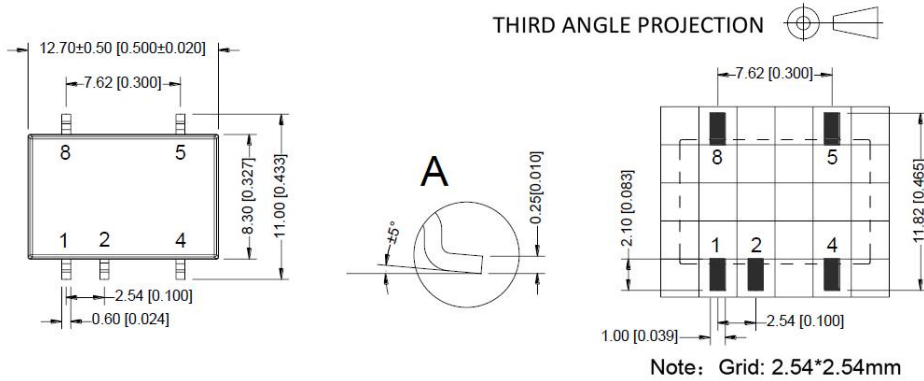

Pin-out	
Pin	Mark
1	-Vin
2	+Vin
4	GND
5	+Vo
8	NC

Note:
 Unit:mm[inch]
 Pin section tolerances: ±0.10mm[±0.004 inch]
 General tolerances: ±0.25mm[±0.010inch]

NC: Pin to be isolated from circuitry

Packing Code	L x W x H	
ANT	12.7X11.00X7.13 mm	0.50X0.433X0.281inch

Ripple & Noise Test: (Twisted Pair Method 20MHZ bandwidth)

Test Method:
 a. 12# twisted pair to connect, Oscilloscope bandwidth set as 20MHz, 100M bandwidth probe, terminated with 0.1uF polypropylene capacitor and 10uF high frequency low resistance electrolytic capacitor in parallel, oscilloscope set as Sample pattern.
 b. Input terminal connect to power supply, output terminal connect to electronic load through jig plate, Use 30cm±2 cm sampling line, Power line selected from corresponding diameter wire with insulation according to the flow of output current.

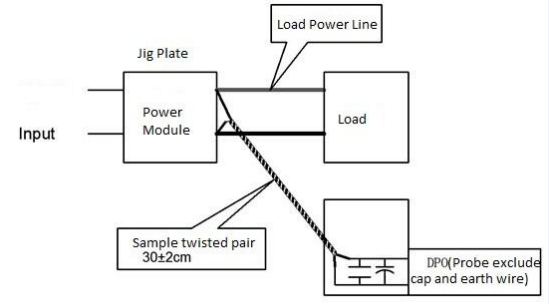

Products Characteristic Curve

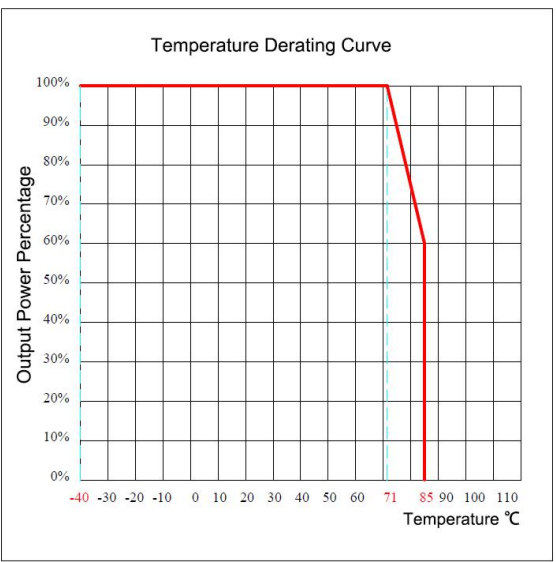

Application Circuit

1. Output load requirements

- a. In order to ensure the converter can work reliably with high efficiency, the minimum load should not less than 10% rated load when it is used. If the needed power is indeed small, please parallel a resistor at the output side, the resistance equal to 10% nominal load.
- b. The maximum capacitive load is tested under nominal input full load, and cannot exceed the maximum capacitive load of output terminal under operation, otherwise it will cause it difficult to start up and damage the product.

2. Recommended circuit

In order to ensure the input/output ripple and noise decreased, capacitor filter net could be connected to input and output terminal, application circuit as below photo 1; choosing suitable filter capacitor is very important, start-up problems may be caused by too large capacitance. To ensure the modules running safely and reliably, the recommended capacitive load values as shown in Table 1.

Single Output

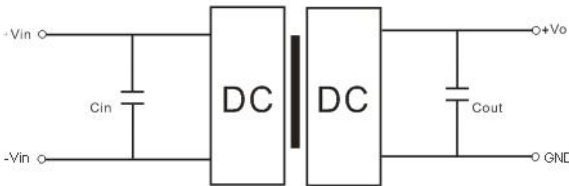

Dual Output



Recommended capacitive load value (Table 1)

Vin (Vdc)	Cin	Single Vout Vdc	Cout (μF)	Dual Vout (Vdc)	Cout (μF)
5	10 μF/16V	3.3	10 μF/16V	±3.3	4.7 μF/16V
12	2.2 μF/25V	5	10 μF/16V	±5	4.7 μF/16V
15	2.2 μF/25V	9	2.2 μF/25V	±9	2.2 μF/25V
24	1 μF/50V	12	2.2 μF/25V	±12	1 μF/25V
--	--	15	1 μF/25V	±15	1 μF/16V
--	--	24	1 μF/50V	±24	0.47 μF/50V

3. EMC recommended circuit

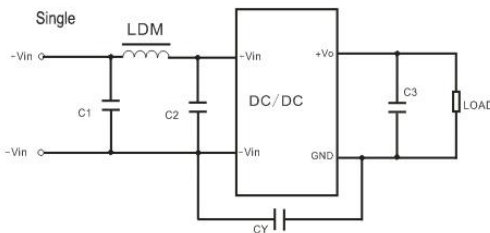

Input Voltage		5VDC	12/15/24VDC
EMI	C1/C2	4.7 μF/16V	4.7 μF/50V
	CY	270pF/6kV	270pF/6kV
	C3	Refer to Cout specs according to Table 1	
	LDM	6.8 μH	6.8 μH

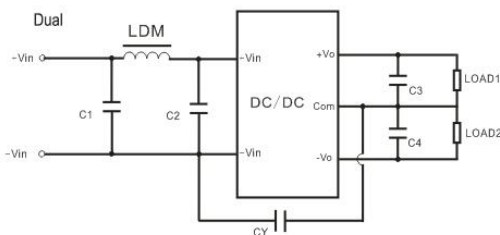

Input Voltage		5VDC	12/15/24VDC
EMI	C1/C2	4.7 μF/16V	4.7 μF/50V
	CY	270pF/6kVdc	270pF/6kVdc
	C3/C4	Refer to Cout specs according to Table 1	
	LDM	6.8 μH	6.8 μH

Packing Information

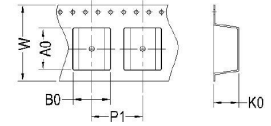
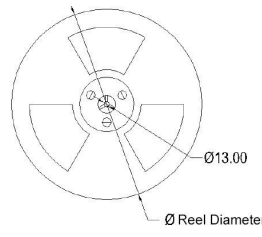
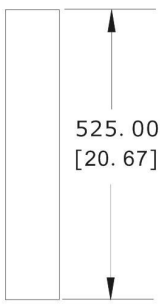
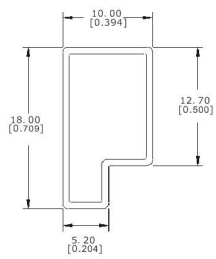

Quadrant assignments for Pin 1 orientation in tape

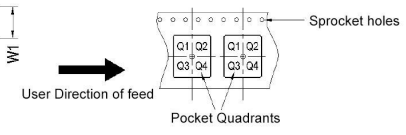

Note:
 Unit:mm(inch)
 General tolerance:±1.50[±0.059]
 Single tube packing qty:39pcs
 Carton packing qty:3120pcs
 Size of single tube:525x18x10mm
 Size of carton:542x110x155mm

Device	Package Type	PIN	SPQ	Reel Diameter (mm)	Reel Width W1(mm)	A0 (mm)	B0 (mm)	K0 (mm)	P1 (mm)	W (mm)	PIN1 Quadrant
NWV75-XXSXXANT	SMD	5	500	330	24.5	13.1	11.7	7.5	16.0	24	Q1

Packing method: Tube

Packing method: Tape and reel(500pc per reel)

- Note:
1. If the product is operated under the min. required load, the product performance cannot be guaranteed to comply with all performance indexes in this datasheet;
 2. The maximum capacitive load is tested under nominal input voltage range and full load condition;
 3. Unless otherwise specified, data in this datasheet are tested under conditions of **Ta=25°C**, **humidity<75%** when inputting nominal voltage and outputting rated load(pure resistance load);
 4. All index testing methods in this datasheet are based on our Company's corporate standards.
 5. We can provide customized product service;

Guangzhou Aipu Electron Technology Co., Ltd
 Address: Building 4, HEDY Park, No.63, Punan Road, Huangpu Dist, Guangzhou, China.
 Tel: 86-20-84206763 Fax: 86-20-84206762 HOTLINE: 400-889-8821
 E-mail: sales@aipu-elec.com Website: www.aipupower.com