

**Typical Features**

- ◆ Wide input voltage range: 85-305VAC/120-430VDC
- ◆ No load power consumption ≤ 0.3W
- ◆ Transfer efficiency ( typ. 81%)
- ◆ Switching Frequency: 65KHz
- ◆ Protections: short circuit, over-current
- ◆ Isolation voltage: 4000Vac
- ◆ Conform to IEC62368/UL62368/EN62368 test standard
- ◆ With CE, RoHS certificate
- ◆ Plastic case, meet UL94 V-0
- ◆ PCB mounting

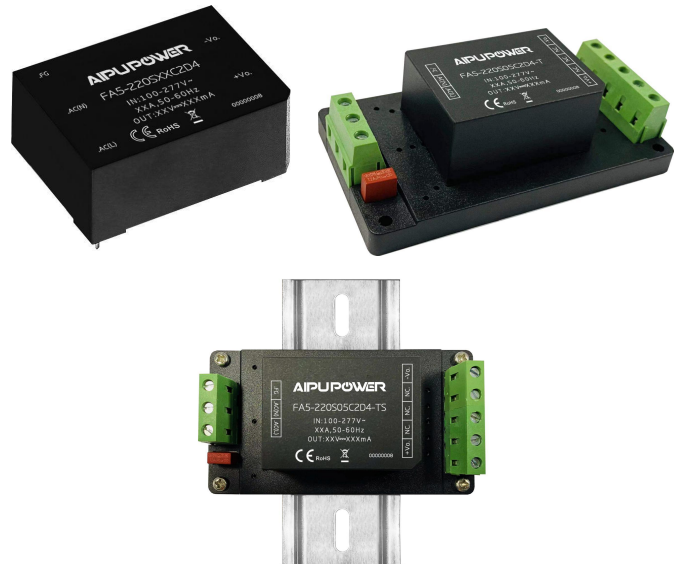

**Application Field**

**FA5-220SXXC2D4 Series** ----- a compact size, high efficient, pass CE standard power module offered by Aipu. It features universal input voltage range, DC and AC dual-use, low ripple, low temperature rise, low power consumption, high efficiency, high reliability, safer isolation. with good EMC performance, meet international EN55032、IEC/EN61000 standard. This series have wide application for power, industrial, instrument, smart home field. The application circuit in the datasheet is strongly recommended for harsh EMC environment.

**Typical Product List**

Certificate	Part No	Output Specifications			Max. Capacitive Load	Ripple & Noise 20MHz (Max)	Efficiency @ full load, 220Vac (typical)
		Power	Voltage	Current			
		(W)	Vo(V)	Io(m A)			
CE/RoHS	FA5-220S3V3C2D4	3	3.3	1000	4000	100	67
CE/RoHS	FA5-220S05C2D4	5	5	1000	4000	100	72
CE/RoHS	FA5-220S09C2D4	5	9	556	1000	100	74
CE/RoHS	FA5-220S12C2D4	5	12	416	500	100	80
CE/RoHS	FA5-220S15C2D4	5	15	333	400	100	81
CE/RoHS	FA5-220S24C2D4	5	24	208	220	150	81

Note 1: Suffix "-T" for chassis, "-TS" din-rail mounting, rail width is 35mm;

Note 2: The typical value of output efficiency is based on full load and burn-in after half an hour.

Note 3: The fluctuation range of full load efficiency at table(%, TYP) is ±2%, full load efficiency = total output power/module's input power.

Note 4: Ripple & Noise is tested by twisted pair method, for details please see (Ripple & Noise Test) at back.

Note 5: For more items, please contact with our sales team.

### Input Specifications

Item	Operating Condition	Min	Typ.	Max	Unit
Input Voltage Range	AC input	85	220	305	VAC
	DC input	120	310	430	VDC
Input Frequency Range	-	47	50	63	Hz
Input Current	115VAC	/	/	0.15	A
	220VAC	/	/	0.1	
Surge Current	115VAC	/	/	10	
	220VAC	/	/	20	
Leakage Current	-	0.5mA TYP/230VAC/50Hz			
External Fuse Recommended Value	-	1A-3A/250VAC slow-fusing			
Hot-plug	-	unavailable			
Remote Control Terminal	-	unavailable			

### Output Specifications

Item	Operating Condition	Min	Typ.	Max	Unit
Voltage Accuracy	Full input voltage range, any load	-	±2.0	±5.0	%
Line Regulation	Nominal load	-	-	±2.0	%
Load Regulation	Nominal input voltage 20%~100% load	-	-	±4.0	%
No Load Power Consumption	Input 115VAC	-	-	0.3	W
	Input 220VAC	-	-		
Minimum Load	Single Output	0	-	-	%
Start-up Delay Time	Nominal input voltage (full load)	-	1000	-	mS
Power-off Holding Time	Input 115VAC (full load)	-	50	-	mS
	Input 220VAC (full load)	--	100	-	
Dynamic Response	25%~50%~25%	-5.0	-	+5.0	%
	50%~75%~50%	-5.0	-	+5.0	mS
Output Overshoot	Full input voltage range	≤10%Vo			%
Short Circuit Protection		Continuous, Self-recovery			Hiccup
Temperature Coefficient	-	-	±0.03%	-	%/°C
Over Current Protection	Full input voltage range	≥120% Io self-recovery			Hiccup

**General Specifications**

Item	Operating Condition	Min	Typ.	Max	Unit
Switching Frequency	-	-	65	-	KHz
Operating Temperature	-	-40	-	+75	°C
Storage Temperature	-	-40	-	+85	
Soldering Temperature	Wave-soldering	260±4°C, timing 5-10S			
	Manual-soldering	360±8°C, timing 4-7S			
Relative Humidity	-	10	-	90	%RH
Isolation Voltage	Input-Output Test 1min, leakage current≤5mA	4000	-		VAC
Insulation Resistor	Input-Output@DC500 V	100	-		MΩ
Safety Standard	-	EN62368, IEC62368			
Vibration	-	10-55Hz, 10G, 30Min, along X,Y,Z			
Class of Case Material	-	UL94 V-0			
MTBF	-	MIL-HDBK-217F@25°C > 300,000H			

**EMC Characteristics**

Total Item	Sub Item	Test Standard	Class	
E M C	EMI	CE	CISPR22/EN55032 CLASS B (recommend circuit see photo1)	
		RE	CISPR22/EN55032 CLASS B (recommend circuit see photo1)	
	EMS	RS	IEC/EN61000-4-3	10V/m Perf.Criteria B (recommend circuit see photo1)
		CS	IEC/EN61000-4-6	3Vr.m.s Perf.Criteria B (recommend circuit see photo1)
		ESD	IEC/EN61000-4-2	Contact ±6KV / Air ±8KV Perf.Criteria B
		Surge	IEC/EN61000-4-5	line to line ±2KV / line to ground ±4KV Perf.Criteria B (see recommend circuit photo 1)
		EFT	IEC/EN61000-4-4	±2KV Perf.Criteria B
		Voltage dips, short interruptions and voltage variations immunity	IEC/EN61000-4-11	0%~70% Perf.Criteria B

**C2 Dimension**

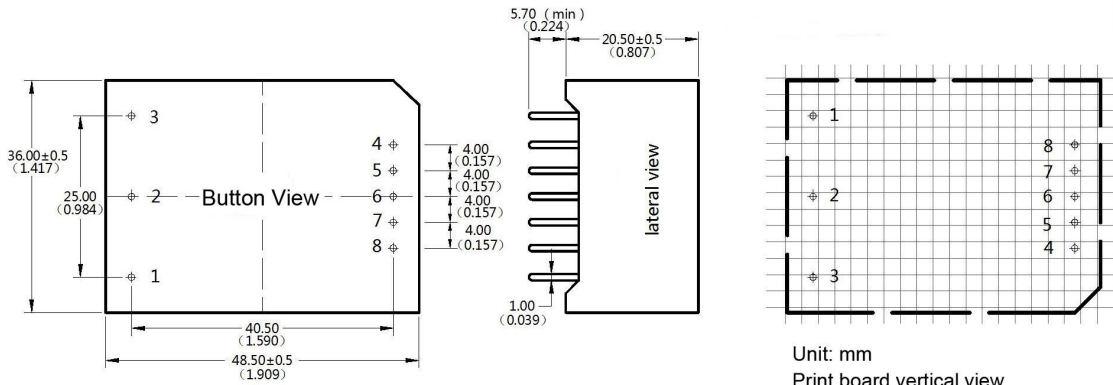

Unit: mm  
 Print board vertical view  
 Grid: 2.54mm(0.1inch)  
 General tolerance: ±0.25mm  
 Pin section tolerances: ±0.10mm

**C2-T Dimension**

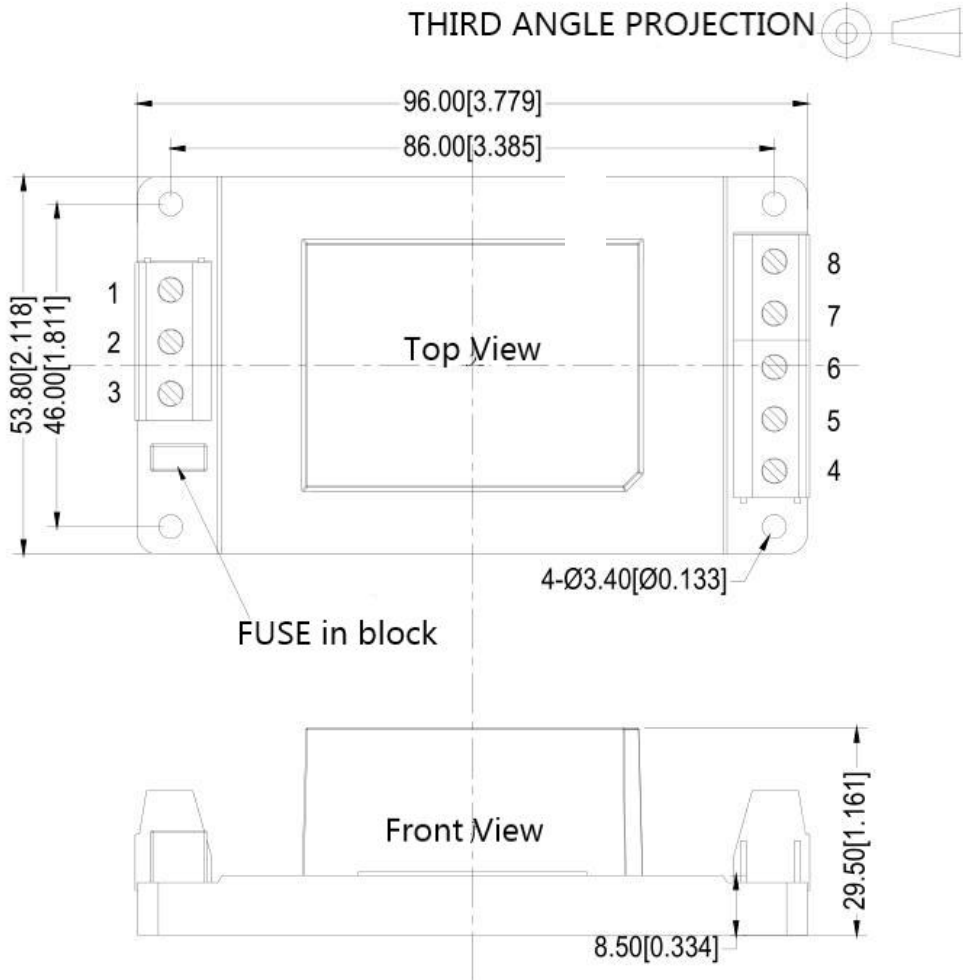

Note:  
 Unit:mm[inch]  
 General tolerance:±0.50mm[±0.019inch]

**C2-TS Dimension**

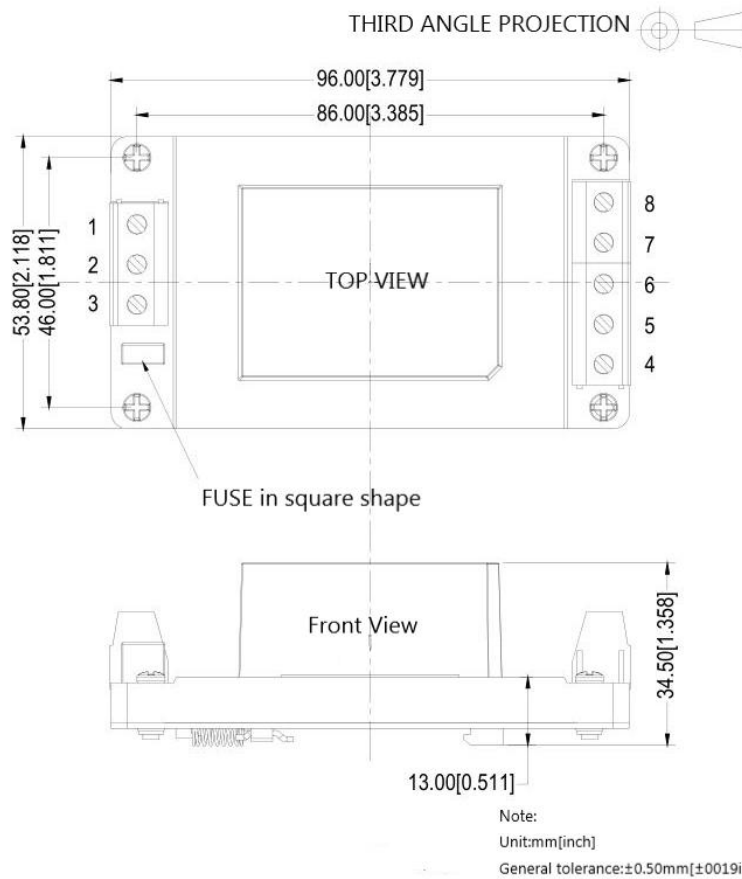

Packing Code	L x W x H	
C2	48.5 x 36.0 x 20.5 mm	1.909 × 1.417 × 0.807inch
C2-T	96 x 53.8 x 29.5mm	3.780X2.118X1.161inch
C2-TS	96 x 53.8 x 34.5mm	3.780X2.118X1.358inch

**Pin Definition**

Pin	1	2	3	4	8
Single(S)	FG	AC(N)	AC(L)	+Vo	-Vo

Note: If the definition of pin is not in accordance with the model selection manual, please refer to the label on actual item.

**Ripple& Noise Test: (Twisted Pair Method 20MHZ bandwidth)**

Test Method:

(1) 12# twisted pair to connect, Oscilloscope bandwidth set as 20MHZ, 100M bandwidth probe, terminated with 0.1uF polypropylene capacitor and 10uF high frequency low resistance electrolytic capacitor in parallel, oscilloscope set as Sample pattern.

(2) Input terminal connect to power supply, output terminal connect to electronic load through jig plate, Use 30cm±2 cm sampling line, Power line selected from corresponding diameter wire with insulation according to the flow of output current.

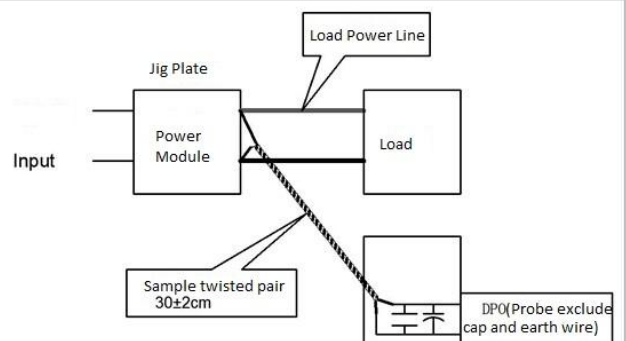

**Product Characteristic Curve**

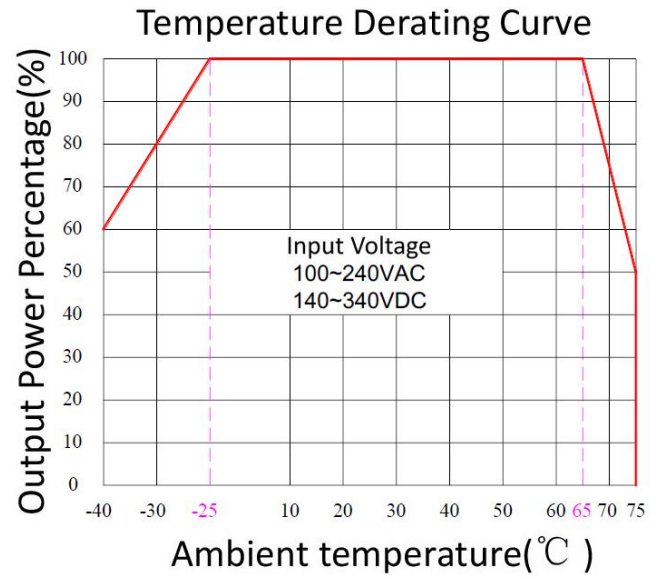
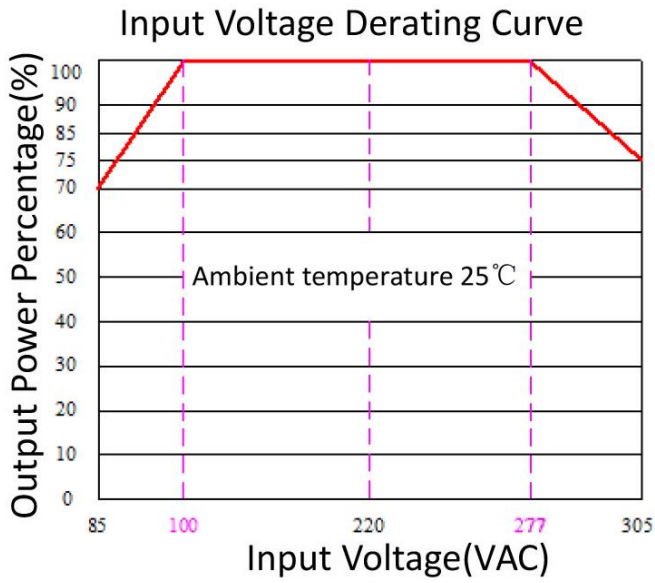

Note 1: Input Voltage should be derated based on input voltage derating curve when it is 85~100VAC/277~305VAC/120~140VDC/390~430VDC.  
 Note 2: Our product is suitable to use under natural air cooling environment, if use it under closed condition, please contact with us.

**Typical EMC Recommended Circuit:**

Photo 1: EMC for high requested circuit

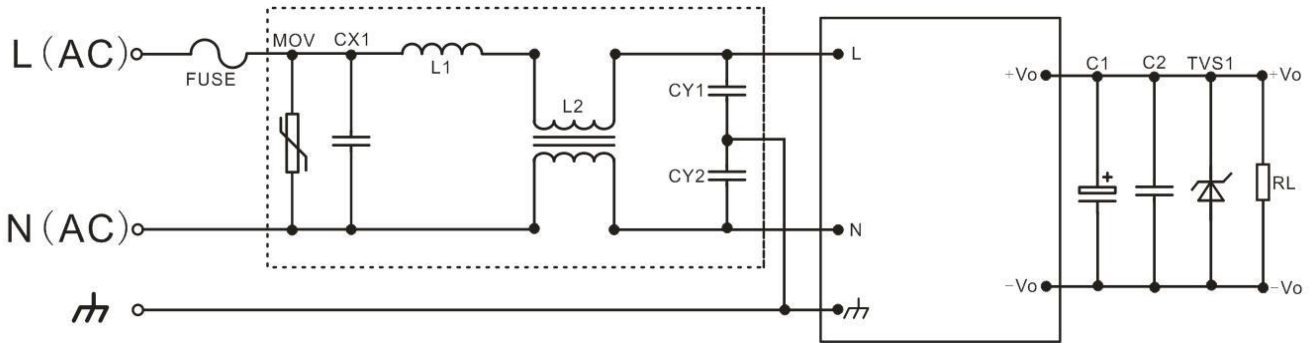

Component	Value
FUSE	3.15A/250Vac, slow fusing, necessary
MOV	14D471K
CX1	0.22uF/275Vac
L1	2.0uH/2.5A (I inductor)
L2	Green ring 15mH/2.5A T12X7X6mm
CY1/CY2	102M-400Vac

**Note :**

- 1) C1 choose high frequency low impedance electrolytic capacitor, the capacitance value less than capacitive load, withstand voltage is 1.5 times more than output voltage;
- 2) C2 choose 0.1uF ceramic chip capacitor, withstand voltage is 1.5 times more than output voltage;
- 3) TVS1 is TVS tube; 5V output recommend:SMBJ7.0A, 9V output recommend:SMBJ12.0A, 12V output recommend:SMBJ20A, 15V output recommend:SMBJ20.0A, 24V output recommend:SMBJ30.0A, 48V output recommend:SMBJ64A.

**Note:**

1. The product should be used within the specification range, or it will cause permanent damage to it;
2. The input terminal should connect to fuse;
3. If the product is operated under the minimum load, the product performance cannot be guaranteed to comply with all parameters in the datasheet;
4. If the product is worked beyond the required load range, the product performance cannot be guaranteed to comply with all parameters in the datasheet;
5. Unless otherwise specified, parameters in this datasheet were measured under the conditions of  $T_a=25^{\circ}\text{C}$ , humidity<75% with nominal input voltage and rated output load(pure resistance load);
6. All index testing methods in this datasheet are based on our Company's corporate standards;
7. The performance indexes of the product models listed in this manual are as above, but some indexes of non-standard model products will exceed the above-mentioned requirements, please directly contact our technician for specific information;
8. We can provide product customization service,
9. Specifications are subject to change without prior notice.

**Guangzhou Aipu Electron Technology Co., Ltd**

Address: Building 4, HEDY Park, No.63, Punan Road, Huangpu Dist, Guangzhou, China.

Tel: 86-20-84206763 Fax: 86-20-84206762 HOTLINE: 400-889-8821

E-mail: sales@aipu-elec.com Website: <http://www.aipupower.com>